

FLEXFORM



PERRY ANTONIO CITTERIO 2022|2023

DIVANI | DIVANI COMPONIBILI | POUF SOFAS | SECTIONAL SOFAS | OTTOMANS

FLEXFORM Spa

Via Einaudi 23/25 20821 Meda (MB) Italy | Tel. +39 0362 3991 | Fax +39 0362 399228 | info@flexform.it | www.flexform.it

PERRY | ANTONIO CITTERIO | 2022|2023

Struttura

in legno massello con imbottitura in poliuretano espanso a densità variabile rivestito in tessuto protettivo accoppiato e strato esterno in piuma d'oca sterilizzata (certificata Assopiuma, etichetta Oro)

Bracciolo portariviste

in metallo rivestito in cuoio nei colori: bianco 5007, sabbia 5001, oliva 5006, tabacco 5015, rosso bulgaro 5008, testa di moro 5004, testa di moro scuro 5013, grigio 5003, nero 5005, scamosciato moro 6004, scamosciato nero 6005, scamosciato oliva 6003, scamosciato sabbia 6001.

Base in metallo verniciato a forno con polveri epossidiche di colore antracite lucido.

Appoggio a terra su piedi in materiale termoplastico

Cuscini optional

in piuma d'oca sterilizzata (certificata Assopiuma, etichetta Oro), a richiesta con supplemento di prezzo

Base divano e bracciolo

in metallo verniciato a forno con polveri epossidiche di colore antracite lucido.

Appoggio a terra su piedi in materiale termoplastico

Rivestimento

sfoderabile sia nella versione in tessuto che nella versione in pelle

Profilo rivestimento

la confezione prevede un profilo in gros grain che può essere realizzato in tutti i colori della cartella campioni, anche nella finitura in PVC/effetto pelle

Structure

in solid wood with variable density polyurethane foam padding enveloped in protective laminated fabric and an external layer of sterilized goose down (Assopiuma certified, Gold label)

Magazine-holder armrest

in metal, clad in cowhide in these colors: white 5007, sand 5001, olive 5006, tobacco 5015, Bulgarian red 5008, dark brown 5004, extra dark brown 5013, grey 5003, black 5005, dark brown suede 6004, black suede 6005, olive suede 6003, sand suede 6001.

Base in epoxy powder-coated metal, glossy anthracite color.

Sits on feet made of thermoplastic material

Optional cushions

in sterilized goose down (Assopiuma certified, Gold label); optional cushions are upon request with upcharge

Sofa and armrest base

in epoxy powder-coated metal, glossy anthracite color.

Sits on feet made of thermoplastic material

Upholstery

is removable in both the fabric and leather versions

Upholstery piping

upholstery detailing includes grosgrain piping that can be crafted in all the colors on the sample board, including in the PVC/leather-look finish

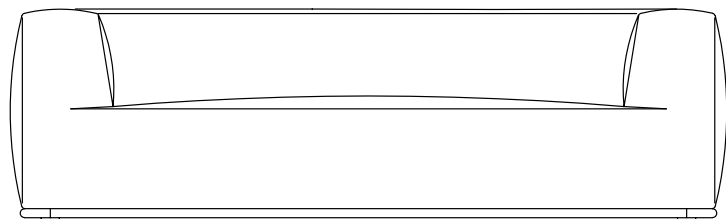













29303

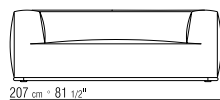
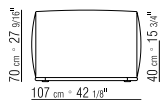

29304

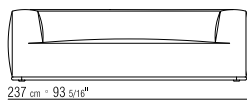

29305

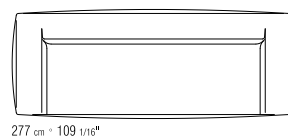
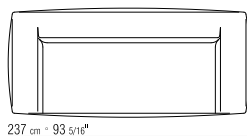
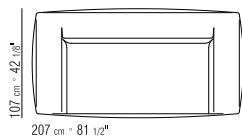

29307

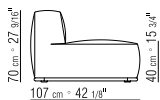

29308

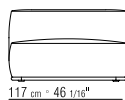

29311

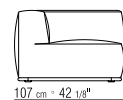
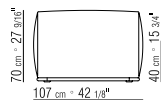

29313

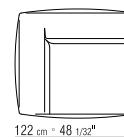
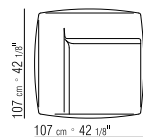
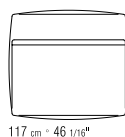
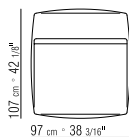
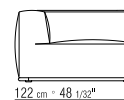

29315

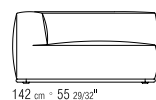
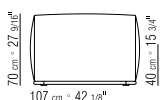

29317

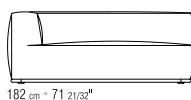

29319

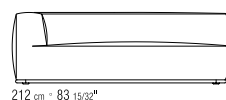

29321

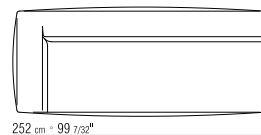
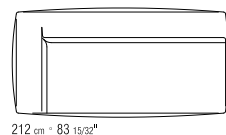
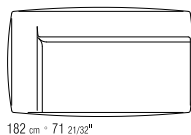
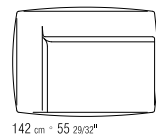
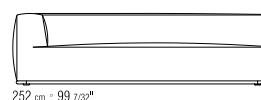

29341

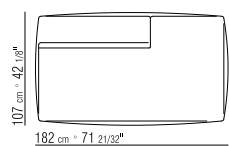
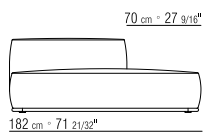
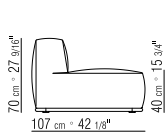

29343

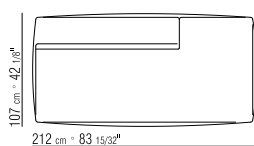
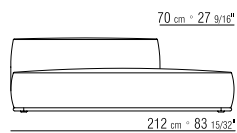

29345

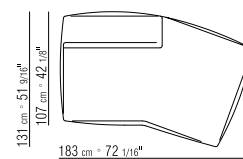
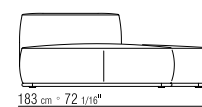
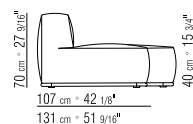

29347

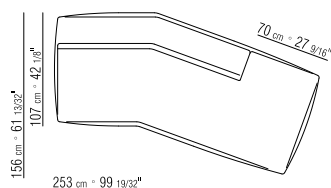
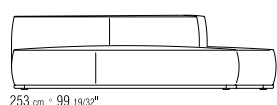
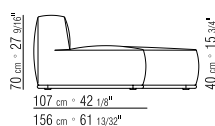

29349

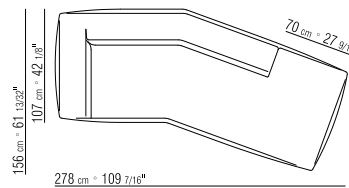
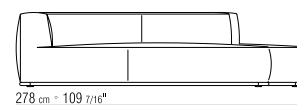
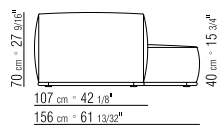

29350

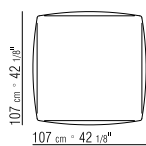
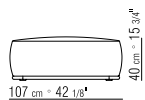

29351

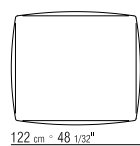
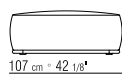

29352

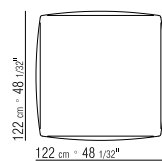
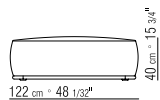
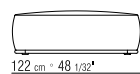

29377

29379

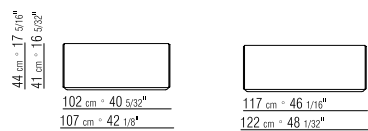
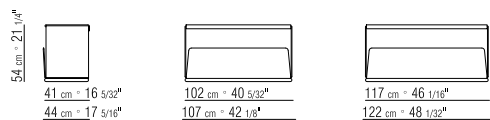

293A3

293A4

293A5

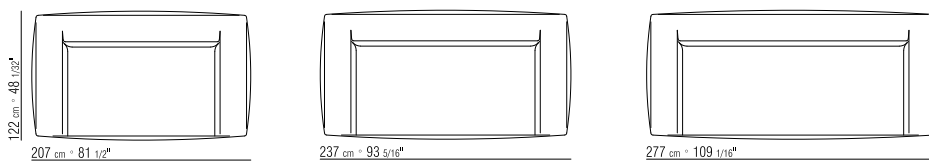
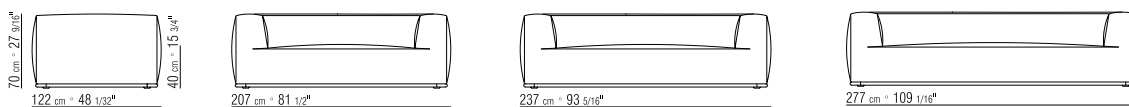

293A7

293A8

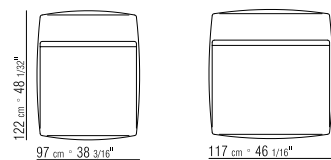
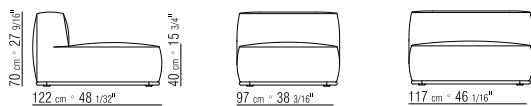

293B3

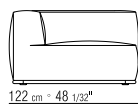
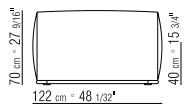

293B5

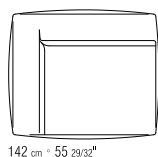
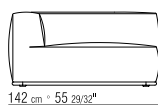

293B7

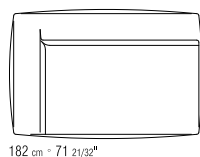
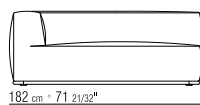

293B9

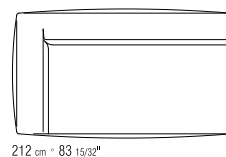
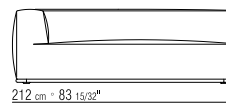

293C1

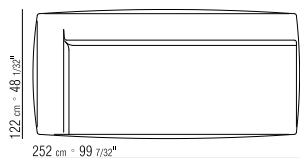
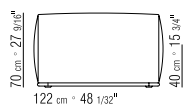

293D1

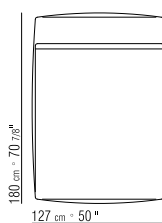
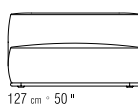
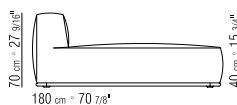

293D3

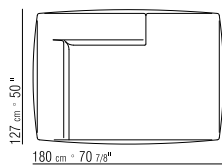
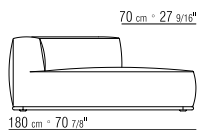
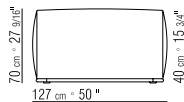

293D9

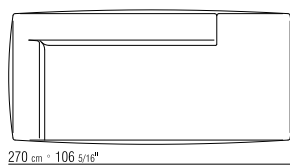
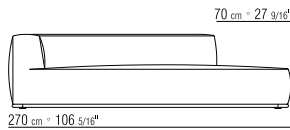

293D5

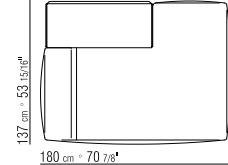
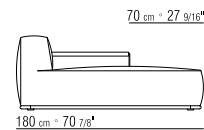
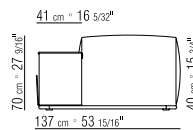

29335

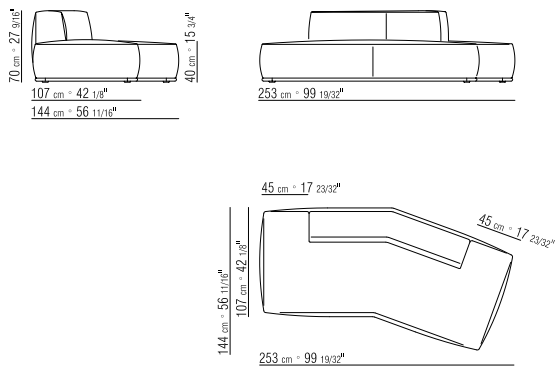

293F1

293F3

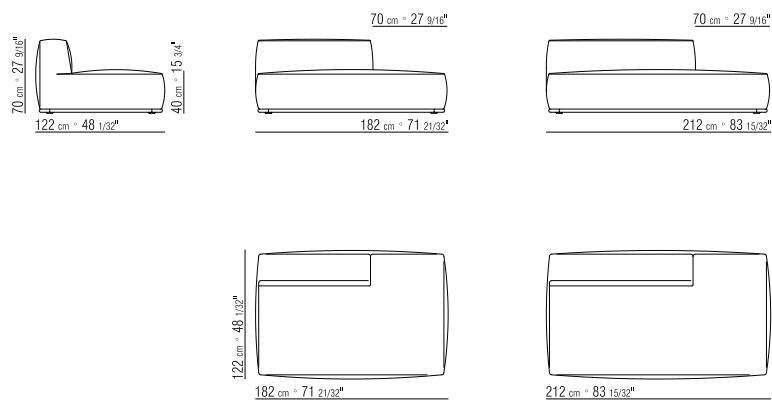

29398

29399

