

Gallotti&Radice



Venere

2013

Vanity wooden desk covered by 6mm tempered glass and 10mm tempered shelf, both painted as per samples in the bright or satin version. Rotating (360°) double face mirror diam. 50cm. Magnifying mirrored insert, on request. Chestnut with “fabric” touch effect lacquered drawers. Burnished lacquered metal structure. Small boxes in metal covered by suede Sand 012. The mirror will be on the left side.

Cm (L x W x H)

Con specchio / With mirror

124 x 60 x 136

144 x 60 x 136

Senza specchio / Without mirror

124 x 60 x 86

144 x 60 x 86

Inches (L x W x H)

Con specchio / With mirror

49 x 23³/₄ x 53³/₄

56³/₄ x 23³/₄ x 53³/₄

Senza specchio / Without mirror

49 x 23³/₄ x 34

56³/₄ x 23³/₄ x 34

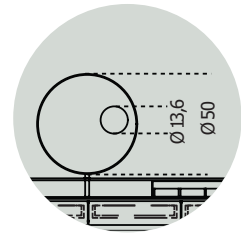
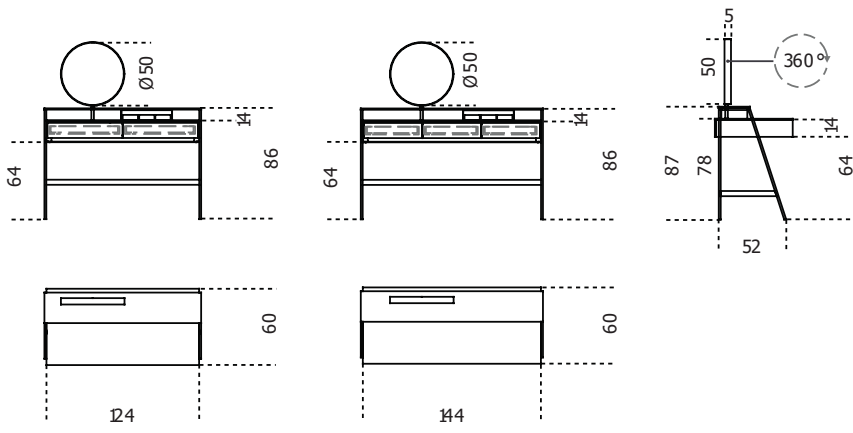

Specchio ingranditore
Magnifying mirror

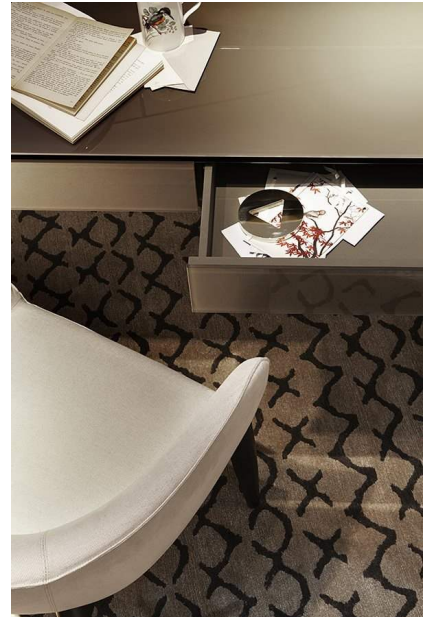

Finishings

Glass



Bright black



Bright blue-grey



Bright cadet blue



Bright cement



Bright
champagne



Bright dark grey



Bright green-
grey



Bright liquorice

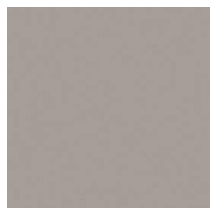

Bright mink

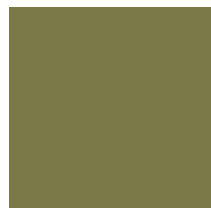

Bright olive



Bright rose
powder

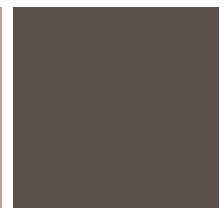

Bright taupe
powder



Bright white

Mirror

Satin black

Satin blue-grey

Satin cadet blue

Satin cement

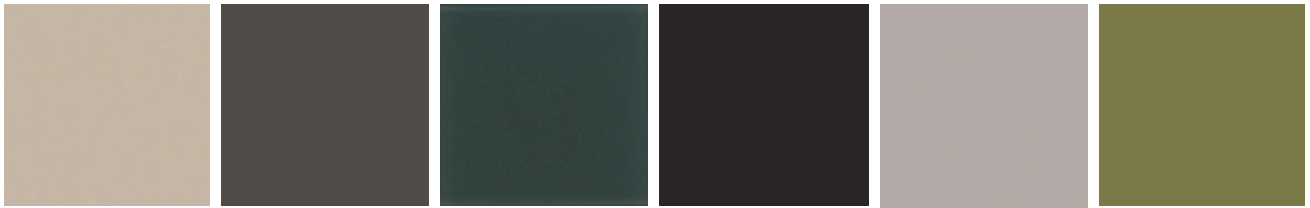

Satin champagne

Satin dark grey

Satin green-grey

Satin liquorice

Satin mink

Satin olive

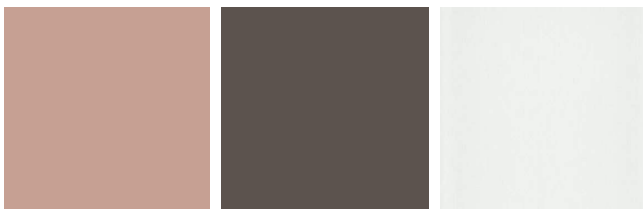

Satin rose powder

Satin taupe

Satin white

Metal



Burnished
lacquered metal

Chestnut fabric
touch effect

Leather Cat.L1



Suede sand 012